

Oxidation Reaction of the Copper(I) Phenoxo Complex [(phen)(Ph₃P)Cu(OPh)]: the Formation of the Copper(II) Derivative [(phen)Cu(OPh)(OC₆H₄-2-(OH))], Having a Catechol Group Derived from Phenol Hydroxylation Reaction

GIROLAMO LA MONICA, M. ANGELA ANGARONI, FRANCO CARIATI, SERGIO CENINI and G. ATTILIO ARDIZZOIA
 Dipartimento di Chimica Inorganica e Metallorganica, Centro C.N.R., Via G. Venezian 21, 20 133 Milan, Italy

(Received December 3, 1987)

Abstract

The copper(I) bicarbonato complex [(phen)-(Ph₃P)Cu(O₂COH)] (1) (phen = 1,10-phenanthroline) reacts under nitrogen with phenol giving the copper(I) phenoxo derivative [(phen)(Ph₃P)Cu(OPh)] (2). Complex 2 was shown to undergo a facile hydrolysis, PhOH being released. The action of moist CO₂ on 2 allowed the isolation of the starting bicarbonato complex 1.

The reaction of 1 with excess phenol under an oxygen atmosphere, gave the unexpected copper(II) derivative [(phen)Cu(OPh)(OC₆H₄-2-(OH))] (3). The catechol group, OC₆H₄-2-(OH), which is present in complex 3, originates from a phenol hydroxylation reaction assisted by the copper center. The same complex 3 has been also obtained by reacting 2 with excess PhOH under oxidative conditions.

The bicarbonato complex 1 reacts with catechol under an oxygen atmosphere giving [(phen)Cu(cat)] (4) or the bis(catecholato)copper(II) derivative, (phen)Cu[OC₆H₄-2-(OH)]₂ (5), depending on the molar ratio copper/catechol. The copper(II) complexes 3, 4 and 5 were shown to be sensitive to water; in the case of compounds 3 and 5 a reaction takes place, the Cu–OPh (complex 3) and one of the Cu–OC₆H₄-2-(OH) (complex 5) groups being involved, phenol (complex 3) and catechol (complex 5) being respectively released.

Complex 4, owing to its tendency to retain water of crystallization, converts into [(phen)Cu(cat)]·H₂O (6). From the hydrolysis reactions of 3 and 5,

the catecholato derivative 6 was always obtained, probably through the intermediate formation of the copper(II) hydroxo–catecholato complex [(phen)-Cu(OH)(OC₆H₄-2-(OH))].

Introduction

The copper–alkoxo unit plays an important role in metal-assisted transformations of various organic substrates by copper(I) [1]. In particular, substituted and unsubstituted phenoxo–copper compounds have been prepared and utilized for ether and ester syntheses [2]. The formation of copper–phenoxo intermediates has been proposed in the catalytic conversion of phenol to *ortho*-benzoquinone [3].

We report here the reactions of the bicarbonato–copper(I) [(phen)(Ph₃P)Cu(O₂COH)] (1) [4] with phenol under an inert atmosphere and in the presence of molecular oxygen, and with catechol under oxidative conditions.

Results and Discussion

The results of the reactions described in this paper are summarized in Schemes 1, 2 and 3.

The bicarbonato–copper(I) complex [(phen)-(Ph₃P)Cu(O₂COH)] (1) [4] reacts with phenol under an inert atmosphere giving the phenoxo derivative [(phen)(Ph₃P)Cu(OPh)] (2) (Scheme 1, reaction i). The presence of free PPh₃ in reaction i was shown

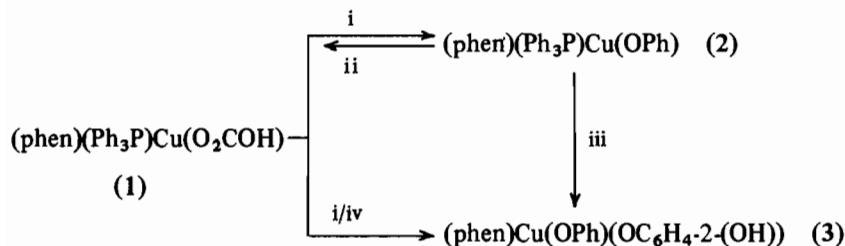

(i) PhOH/N₂; (ii) CO₂/H₂O (–PhOH); (iii) PhOH/O₂; (iv) O₂.

Scheme 1.

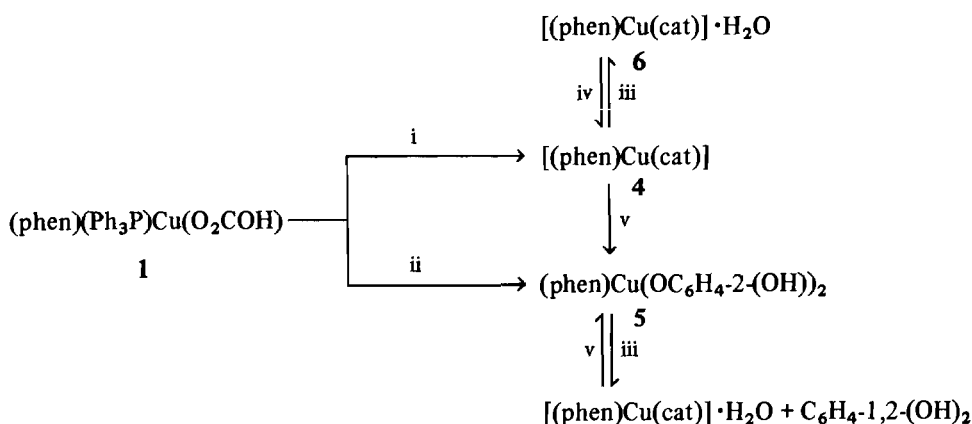

(i) $\text{C}_6\text{H}_4\text{-1,2-(OH)}_2/\text{O}_2$ (ratio 1:catechol = 1:1); (ii) excess $\text{C}_6\text{H}_4\text{-1,2-(OH)}_2/\text{O}_2$; (iii) H_2O ; (iv) suspended in dry solvents; (v) $\text{C}_6\text{H}_4\text{-1,2-(OH)}_2/\text{N}_2$.

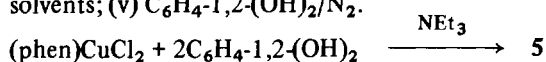

Scheme 2.

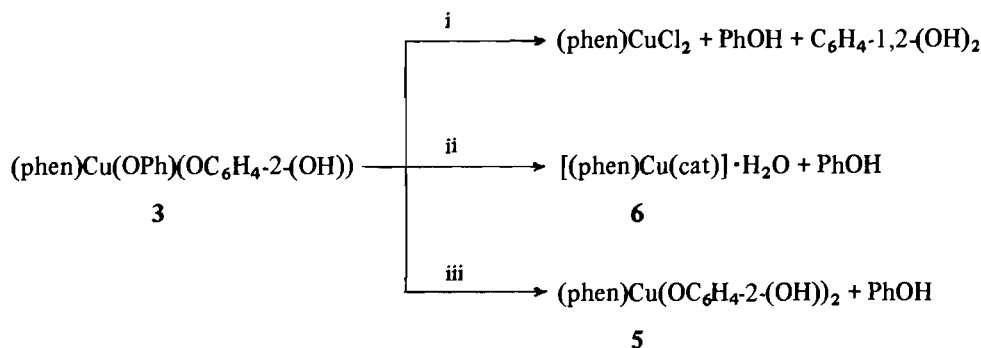

(i) HCl (g); (ii) H_2O (the reaction is reversible, see text); (iii) $\text{C}_6\text{H}_4\text{-1,2-(OH)}_2$.

Scheme 3.

to be essential for the isolation of **2** in an analytically pure form. The phenoxo complex **2** was shown to be stable enough in the solid state and when in solution, provided dioxygen and water, even in traces, are absent. Its sensitivity to moisture is related to a hydrolysis reaction, eqn. (1)

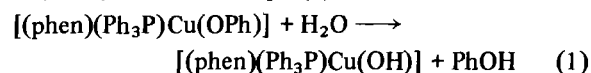

From this reaction free phenol was quantitatively obtained; attempts made in order to isolate and characterize the probable copper(I)-hydroxo compound failed owing to its high lability.

The reaction of **2** with wet CO_2 restored the starting complex **1**, phenol being again released (Scheme 1, reaction ii). This behaviour has been already observed for the related copper(I)-phenoxo complex $(\text{Ph}_3\text{P})_2\text{Cu(OPh)}$ [5].

An unexpected result was achieved when **1** was reacted with excess phenol under a dioxygen atmosphere, eqn. (2)

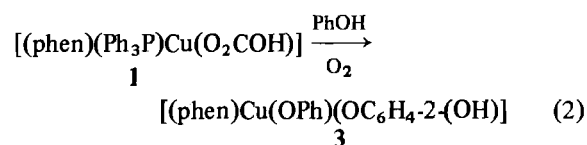

Analytical, spectral data and its reactivity (see later) support the formulation given to complex **3** as a copper(II) derivative containing a phenoxo and a catecholato group as ligands. The latter originates from the selective hydroxylation reaction of a phenoxo group promoted by the copper center. At the moment we are unable to propose any plausible mechanism by which the catecholato anion is formed.

It is to be pointed out that the starting copper(I)-bicarbonato complex **1** does not react with dioxygen under the experimental conditions used in the preparation of **3**.

The oxidation reaction of phenol to *ortho*-benzoquinone catalysed by copper(I) and copper(II) compounds has been extensively investigated and the intermediate formation of copper(II) species having a catechol group as a ligand has been put forward [3].

In order to confirm that a phenoxo complex was in any case the first intermediate species from which complex **3** could be originated, we reacted **2** with excess phenol under a dioxygen atmosphere (Scheme 1, reaction iii): the formation of **3** was verified, thus confirming the previous hypothesis. No triphenylphosphine oxide was detected in the mother liquors of reactions (2) and iii (Scheme 1).

The reaction of the bicarbonato complex **1** with catechol under an oxygen atmosphere has also been investigated (Scheme 2). Depending on the molar ratio between **1** and catechol, two different products are formed, **4** and **5**

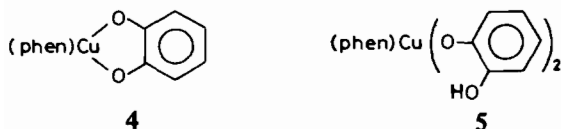

The already known compound **4** [6] is obtained when **1** and catechol are reacted in a molar ratio 1:1, whereas **5** was isolated when excess catechol was used. Moreover, **4** converts into **5** when treated with excess catechol. The bis(catechol)copper(II) derivative (**5**) can be alternatively obtained by reacting $(\text{phen})\text{CuCl}_2$ with catechol in the presence of NEt_3 (Scheme 2).

Reactions of the Copper(II) Complexes

The presence of the phenoxo and the catecholato groups in complex **3** was confirmed by reacting it with gaseous HCl in CH_2Cl_2 (Scheme 3, reaction i). The well known $(\text{phen})\text{CuCl}_2$ was obtained, while in the mother liquor the presence of free phenol and catechol was verified (see 'Experimental'). Further informations on the presence of a phenoxo group in complex **3** were achieved from the observation that it is highly sensitive to moisture. Therefore the reaction of **3** with water in diethyl ether was investigated (Scheme 2, reaction ii). A pale brown insoluble product **A** is readily formed, while the mother liquor was shown to contain free phenol. The latter reaction showed to be reversible: the action of excess phenol on **A** gave again **3**. The nature of complex **A** was investigated: it was confirmed as the copper(II) derivative $[(\text{phen})\text{Cu}(\text{cat})] \cdot \text{H}_2\text{O}$ (**6**). It is to be pointed out that the same complex **6** is obtained when **4** and **5** are left under stirring

in the presence of water (Scheme 2, reaction iii). In particular, catechol was recovered from the mother liquor when complex **5** was used. In these hydrolysis reactions involving **3** and **5**, the intermediate formation of the copper(II)-hydroxo-catecholato complex, $[(\text{phen})\text{Cu}(\text{OH})(\text{OC}_6\text{H}_4\text{-2-(OH)})]$, seems to be a plausible hypothesis.

Phenol is released from complex **3** also by reacting it with excess catechol under a nitrogen atmosphere, the bis(catechol)copper(II) derivative (**5**) being isolated (Scheme 2, reaction iii). On the contrary, no reaction was observed when **3** is treated with excess phenol.

Magnetic Properties of Complexes 3-6

The magnetic moments of complexes **3-6** gave values around 1.8 BM, typical for copper(II) derivatives [7]. Complex **2** was shown to be diamagnetic. The EPR spectra of complexes **3, 4, 5** and **6** are shown in Fig. 1. The EPR parameters of complexes **4** and **6** are typical of distorted elongated tetragonal-bipyramidal complexes with a $d_{x^2-y^2}$ ground state. In fact for an elongated octahedral complex $g_{\parallel} > g_{\perp}$ is foreseen, while for a compressed octahedral complex $g_{\parallel} < g_{\perp} \approx 2.00$ was reported [8].

We found $g_{\parallel} = 2.22$ and $g_{\perp} = 2.06$ for complex **4** and $g_{\parallel} = 2.23$ and $g_{\perp} = 2.08$ for complex **6**. The EPR parameters of **4** are close to those reported in

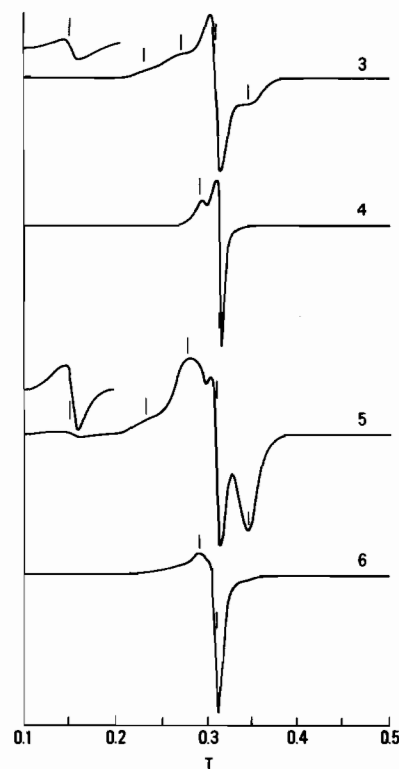

Fig. 1. Polycrystalline powder EPR spectra at X-band frequency and at 123 K of complexes **3, 4, 5** and **6**. Insets show $\times 10$ expansions of the $\Delta M_s = 2$ transitions.

the literature for the $[\text{Cu}(\text{DTBC})_2]^{2-}$ anion (DTBC = di-ter-butyl-catecholato) [9]. The EPR spectra of powdered samples of **3** and **5** are typically triplet in nature with a marked anisotropic zero-field splitting. In fact, in the $\Delta M_s = \pm 1$ region four well resolved signals were found.

These spectra are quite similar to those of other copper(II) dimeric complexes which show the maximum rhombic splitting [10]. Another notable feature of the EPR spectra of complexes **3** and **5** is the presence at 0.15 Tesla ($g = 4.28$) of the so-called 'half-field' spin forbidden $\Delta M_s = 2$ transition between the $M_s = 1$ and $M_s = -1$ component of the triplet state. This band can be assigned only if copper dimers in the solid state are postulated. On the basis of their magnetic moments and EPR spectra, the hypothesis of the possible presence in complexes **3** and **5** of semiquinone ligands must be ruled out. In fact, in this case the EPR spectra of the compounds should show a very sharp signal due to the semiquinone radical, as reported for $[\text{Cu}(\text{DTBSQ})_2]$ (DTBSQ = 3,5-di-ter-butyl-*o*-semiquinato) [11], or should be EPR silent, as reported for $[\text{Cu}(\text{DTBC})(\text{DTBSQ})]^-$ [9] and for $[\text{Cu}(\text{L})(\text{DTBSQ})]^-$ [12].

On the basis of their EPR spectra, it is suggested that complexes **4** and **6** are monomeric in the solid state, with an octahedral type coordination geometry having an elongated tetragonal distortion in which the axial positions are occupied by the oxygen atoms of an other unit which exerts a sort of long-range interaction.

On the contrary complexes **3** and **5** are probably dimeric. This dimerization should occur through the oxygen atoms which are coordinated to the metal or through the oxygen atoms of the OH groups. It is to be pointed out that complexes **3** and **5**, whose IR spectra showed the presence of strong hydrogen bonds (see later), show triplet states (dimeric structures).

Electronic and IR Spectra

The diffuse reflectance spectra of complexes **3–6** show a very intense band at about 459 nm and a shoulder at about 850 nm. None of these transitions can be due to a copper d–d transition, as already reported for complex **4** [13]. Nevertheless, the transitions are clearly due both to the presence of the catechol ligand and of the copper(II) ion; in fact, they are absent in the electronic spectra of complexes $(\text{phen})\text{CuCl}_2$ and $[(\text{phen})(\text{Ph}_3\text{P})\text{Cu}(\text{OPh})]$ (**2**).

According to Amundsen *et al.* [14], the bands at about 450 nm are probably copper(II)–catecholato transitions. However, since a well resolved d–d band was not observed for all complexes reported here, it is not possible to suggest a coordination geometry for these complexes only from their electronic spectra.

The IR spectra of complexes **3–6** all show two characteristic intense bands: one at *ca.* 1480 cm^{-1} and the other at *ca.* 1250 cm^{-1} . The occurrence of these two absorptions represents a very good qualitative evidence for the presence of coordinated catechol, as reported for complexes $(\text{phen})\text{Cu}(\text{cat})$ [13], and $[\text{Co}(\text{trien})(\text{cat})]\text{I}$ [15]. The band at 1480 cm^{-1} corresponds to a skeleton stretching vibration of the aromatic ring [16], while the band at around 1250 cm^{-1} can be probably assigned to a C–O stretching of the catechol ligand. Moreover the free catechol dianion shows C–O stretching vibrations at around 1250 cm^{-1} [15].

The IR spectrum of $[(\text{phen})(\text{Ph}_3\text{P})\text{Cu}(\text{OPh})]$ (**2**) shows strong bands at 1480 and 1320 cm^{-1} . The first can be assigned to an aromatic ring stretching and the latter to the C–O stretching vibration of the phenoxo group. In fact, a similar absorption was found in the IR spectra of phenol itself and of its anion [16]. It is known that the IR spectra of phenol and of substituted phenols, when registered in diluted solutions, show a very sharp band at *ca.* 3600 cm^{-1} due to $\nu(\text{OH})$ [17]. On the contrary the IR spectra of the same products registered as non-diluted samples (liquid films or solid samples) show a very large band in the 3400–3200 cm^{-1} region again due to $\nu(\text{OH})$ stretching (the position depends on the amount of the interaction due to hydrogen bonds) [17].

Complexes **3** and **5** show in their IR spectra bands at *ca.* 3000 (very broad) and 3200 (broad) cm^{-1} respectively. On this basis, it can be postulated that in complexes **3** and **5** strong intra or intermolecular hydrogen bonds are present.

Experimental

Phenol and catechol were of reagent grade quality and were used without further purification. Solvents were purified and dried by standard methods. IR spectra were taken on a Perkin-Elmer Mod. 781 spectrophotometer as voltalef 3S oil (BDH) mulls in the range 4000–1300 cm^{-1} and as nujol mulls in the range 1300–600 cm^{-1} . Magnetic measurements were obtained on a Faraday balance equipped with a Cahn electromagnet and a Cahn 1000 microbalance. EPR spectra of powdered samples were recorded on a Varian E-9 spectrometer equipped with X-band. Diffuse reflectance electronic spectra were obtained with a Beckman DK-2A spectrophotometer.

Analytical data for the complexes are given in Table I.

$[(\text{phen})(\text{Ph}_3\text{P})\text{Cu}(\text{OPh})]$ (**2**)

A THF suspension (10 ml) of PPh_3 (0.23 mmol), PhOH (0.18 mmol) and $[(\text{phen})(\text{Ph}_3\text{P})\text{Cu}(\text{O}_2\text{COH})]$ (**1**) (0.18 mmol), was refluxed for 1 h under a nitro-

TABLE I. Analytical Data

Complex	Melting point (°C)	Analyses: found(calc.) (%)			
		C	H	N	O
2 [(phen)(Ph ₃ P)Cu(OPh)]	133	71.87 (72.18)	4.75 (4.67)	4.67 (4.67)	2.74 (2.67)
3 [(phen)Cu(OPh)(OC ₆ H ₄ -2-(OH))]	>250	64.01 (64.65)	4.12 (4.04)	6.27 (6.29)	11.15 (10.77)
4 [(phen)Cu(cat)]	>250	61.08 (61.45)	3.59 (3.41)	7.75 (7.96)	9.22 (9.10)
5 [(phen)Cu(OC ₆ H ₄ -2-(OH)) ₂]	210	61.82 (62.40)	3.89 (3.90)	6.2 (6.07)	13.6 (13.87)
6 [(phen)Cu(cat)]·H ₂ O	>250	58.16 (58.46)	3.93 (3.79)	7.68 (7.73)	12.6 (12.99)

gen atmosphere. CO₂ evolution was verified. The orange solution was evaporated to dryness and the residue treated with diethyl ether. The orange complex 2 was filtered off, washed with diethyl ether and dried under vacuum. Its IR spectrum showed significant strong bands at 1480 and 1320 cm⁻¹.

[(phen)Cu(OPh)(OC₆H₄-2-(OH))]₂ (3)

Method A. To an acetone suspension (10 ml) of [(phen)(Ph₃P)Cu(O₂COH)] (1) (0.35 mmol), phenol (2.45 mmol) was added under an inert atmosphere. After 30 min dioxygen was introduced and the brown product 3 was obtained as an insoluble material. After 1 h it was filtered off, washed with acetone and dried under vacuum.

Method B. To a THF suspension (5 ml) of [(phen)Cu(cat)] (4) or [(phen)Cu(cat)]·H₂O (6) (0.2 mmol), phenol (3.84 mmol) was added. After 12 h the insoluble brown product 3 was filtered off, washed with THF and dried under vacuum.

Method C. To a THF suspension (8 ml) of 2 (0.17 mmol), phenol (1.67 mmol) was added under an oxygen atmosphere. After 2 h the brown complex 3 was filtered off, washed with THF and dried under vacuum.

Its IR spectrum showed significant strong absorptions at 1475 and 1260 cm⁻¹.

[(phen)Cu(cat)] (4)

Method A. To THF (10 ml) containing catechol (0.35 mmol) [(phen)(Ph₃P)Cu(O₂COH)] (1) (0.35 mmol) was added under an oxygen atmosphere. The insoluble brown complex 4 formed while CO₂ was evolved. After 1 h it was filtered off, washed with THF and dried under vacuum.

Method B. Complex 4 was obtained also by allowing a suspension of 6 in well dried THF to stir for 1 h. It was recovered as described above for method A.

Its IR spectrum showed significant strong bands at 1475 and 1255 cm⁻¹.

[(phen)Cu(OC₆H₄-2-(OH))₂] (5)

Method A. To THF (10 ml), maintained under an oxygen atmosphere, catechol (1.41 mmol) and 1 (0.35 mmol) were added. Carbon dioxide evolution was verified while the formation of 5 as an insoluble light brown product takes place. After 1 h the product was filtered off, washed with THF and diethyl ether and dried under vacuum.

Method B. To a THF suspension (10 ml) of (phen)CuCl₂ (0.64 mmol), catechol (2.55 mmol) and NEt₃ (1 ml) were added. The green colour of the starting material changed gradually into the light brown colour of complex 5. After 2 h it was filtered off, washed with THF, ethanol and diethyl ether and dried under vacuum.

Method C. Complex 5 was also obtained by reacting a mixture of 4 (0.28 mmol) and catechol (0.85 mmol) in THF, by using the same procedure described for method A.

Method D. Complex 5 can be also obtained by reacting 3 (0.22 mmol) with catechol (0.67 mmol) in THF. After 2 h stirring, the product was filtered off, washed with THF and diethyl ether and dried under vacuum.

Its IR spectrum showed significant bands at 1480 and 1265 cm⁻¹.

Reaction of 2 with Water

To a THF solution of 2, water (3 drops) was added. After 15 min an insoluble yellow-green product was filtered off and the mother liquor was shown to contain free phenol. For the nature of the insoluble copper-containing material, see text.

Reaction of 3, 4 and 5 with Water to Give 6

To a diethyl ether suspension of 3 or 4 or 5, water (3 drops) was added. After 1.5 h the brown insoluble material was filtered off, washed with diethyl ether and dried under vacuum. When 3 or 5 were used, the mother liquors were confirmed to

contain free phenol and free catechol respectively. The IR spectrum of complex **6** showed strong absorptions at 1478 and 1260 cm^{-1} . A broad band is also present at 3430 cm^{-1} ($\nu(\text{OH})$).

Reaction of [(phen)(Ph₃P)Cu(OPh)] (2) with Moist CO₂

Moist carbon dioxide was bubbled through acetone and **2** was added. Within a few minutes the formation of **1** as an insoluble product takes place. In the mother liquor the presence of free phenol was confirmed.

Reaction of 3 with Gaseous HCl

CH₂Cl₂ was saturated with gaseous HCl and **3** was added. After 2 h the green insoluble product was filtered off. It was verified to be (phen)CuCl₂. In the mother liquor the presence of free phenol and catechol was confirmed.

References

- 1 P. Fiaschi, C. Floriani, M. Pasquali, A. Chiesi-Villa and C. Guastini, *Inorg. Chem.*, **25**, 462 (1986).
- 2 M. Kubota and A. Yamamoto, *Bull. Chem. Soc. Jpn.*, **51**, 2909 (1978), and refs. therein.
- 3 J. E. Lyons and C. Y. Hsu, in K. D. Karlin and J. Zubieta (eds.), 'Biological and Inorganic Copper Chemistry', Adenine Press, New York, 1984, pp. 57–84.
- 4 G. La Monica, M. A. Angaroni, F. Cariati and S. Cenini, *Inorg. Chim. Acta*, **143**, 239 (1988).
- 5 T. Yamamoto, M. Kubota and A. Yamamoto, *Bull. Chem. Soc. Jpn.*, **53**, 680 (1980).
- 6 (a) D. G. Brown, J. T. Reinprecht and G. C. Vogel, *Inorg. Nucl. Chem. Lett.*, **12**, 399 (1976); (b) N. E. Emanuel and P. K. Bhattacharya, *Polyhedron*, **5**, 845 (1987).
- 7 B. N. Figgis and J. Lewis, *Prog. Inorg. Chem.*, **6**, 37 (1964).
- 8 (a) B. J. Hathaway and D. E. Billing, *Coord. Chem. Rev.*, **5**, 143 (1970); (b) B. R. McGarvey, *Transition Met. Chem.*, **3**, 89 (1966).
- 9 S. Halmalker, S. E. Jones and D. T. Sawyer, *Inorg. Chem.*, **22**, 2790 (1983).
- 10 (a) A. Bencini, D. Gatteschi, C. Zanchini, J. G. Haasnoot, R. Prins and J. Reedijk, *Inorg. Chem.*, **24**, 2812 (1985); (b) L. Banci, A. Bencini and D. Gatteschi, *J. Am. Chem. Soc.*, **105**, 761 (1983).
- 11 J. S. Thompson and J. C. Calabrese, *J. Am. Chem. Soc.*, **108**, 1903 (1986).
- 12 J. S. Thompson and J. C. Calabrese, *Inorg. Chem.*, **24**, 3167 (1985).
- 13 D. G. Brown, W. J. Hughes and G. Knerr, *Inorg. Chim. Acta*, **46**, 123 (1980).
- 14 A. R. Amundsen, J. Whelan and B. Bosnich, *J. Am. Chem. Soc.*, **99**, 6730 (1977).
- 15 P. A. Wicklund and D. G. Brown, *Inorg. Chem.*, **15**, 396 (1976).
- 16 S. Pinchas, *Spectrochim. Acta, Part A*, **28**, 801 (1972).
- 17 (a) J. C. Evans, *Spectrochim. Acta*, **16**, 1382 (1960); (b) R. J. Jakobsen, *Spectrochim. Acta*, **21**, 433 (1965); (c) J. H. S. Green, D. J. Harrison and W. Kynaston, *Spectrochim. Acta, Part A*, **27**, 2199 (1971).